



Installation instructions, accessories

Volvo Car Corporation Gothenburg, Sweden

Instruction No	Version	Part. No.
6815345	1.1	1286357, 1286358, 31414977, 31414971, 31401807

Decor panel, door



Installation instructions, accessories

Volvo Car Corporation Gothenburg, Sweden

Equipment



IMG-239667

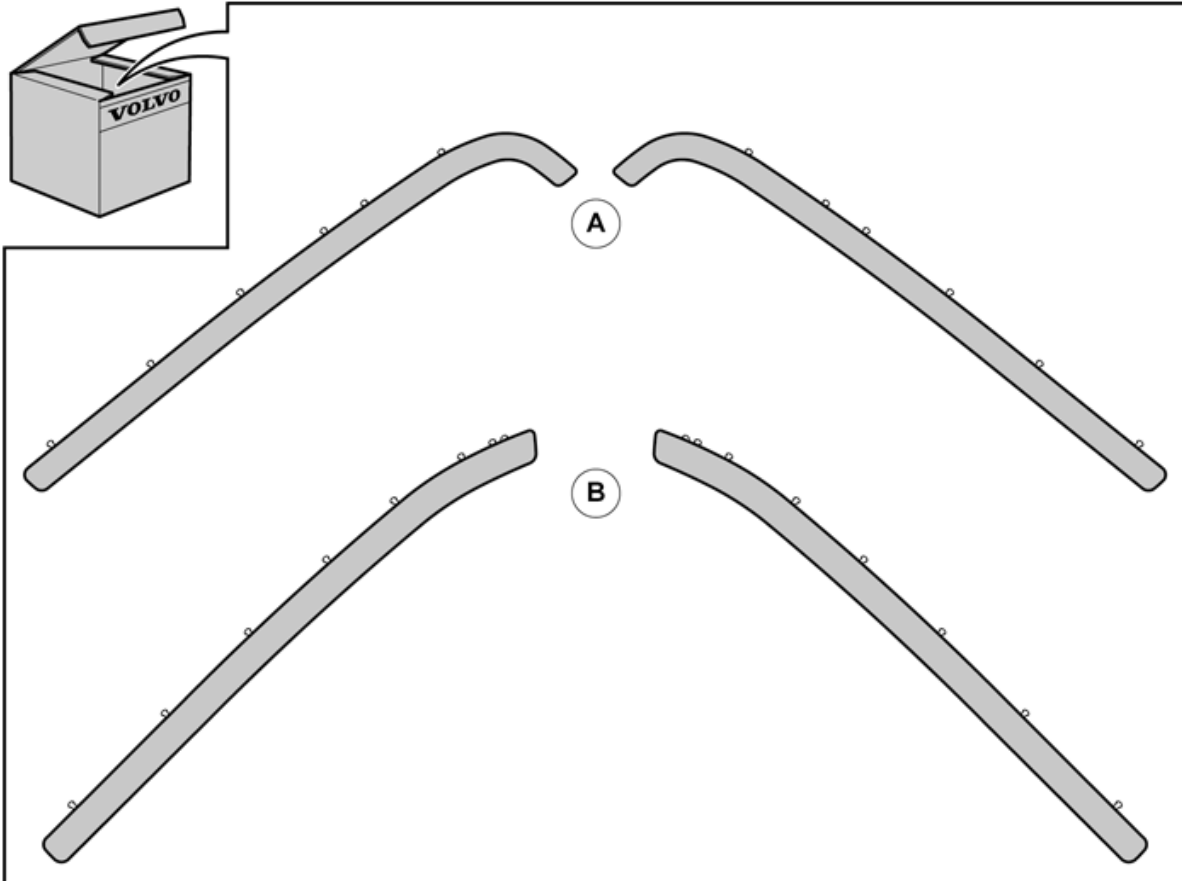

IMG-237390



Installation instructions, accessories

Volvo Car Corporation Gothenburg, Sweden

Information

1

Read through all of the instructions before starting installation.

Notifications and warning texts are for your safety and to minimise the risk of something breaking during installation.

Ensure that all tools stated in the instructions are available before starting installation.

Certain steps in the instructions are only presented in the form of images. Explanatory text is also given for more complicated steps.

In the event of any problems with the instructions or the accessory, contact your local Volvo dealer.

Removal

2

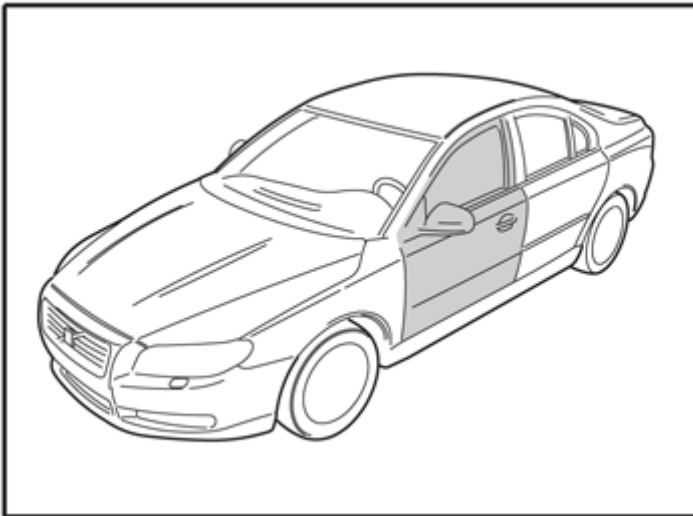

IMG-238700



Installation instructions, accessories

Volvo Car Corporation Gothenburg, Sweden

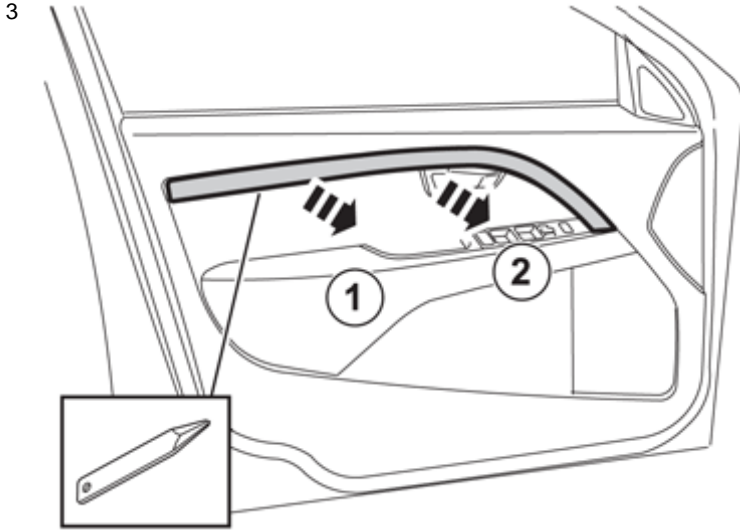

IMG-237391

Accessory installation

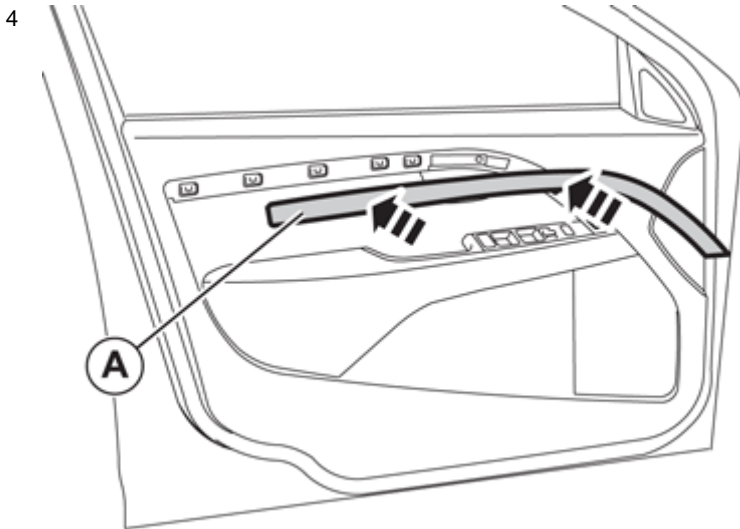

IMG-237392

Removal



Installation instructions, accessories

Volvo Car Corporation Gothenburg, Sweden

5

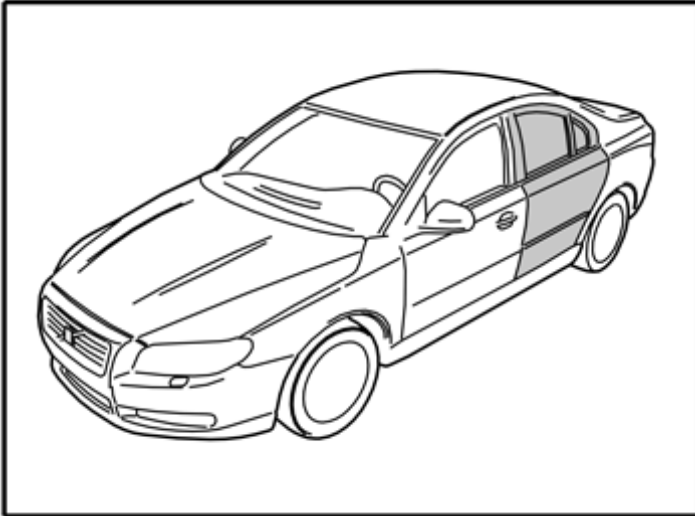

IMG-226529

6

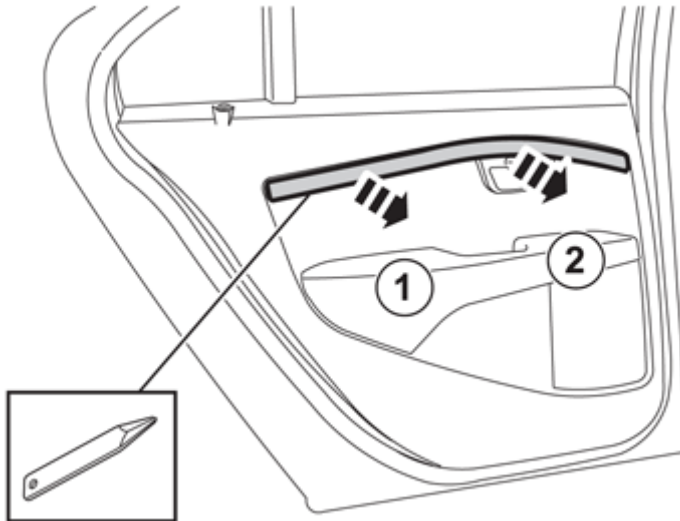

IMG-237393

Accessory installation



Installation instructions, accessories

Volvo Car Corporation Gothenburg, Sweden

7

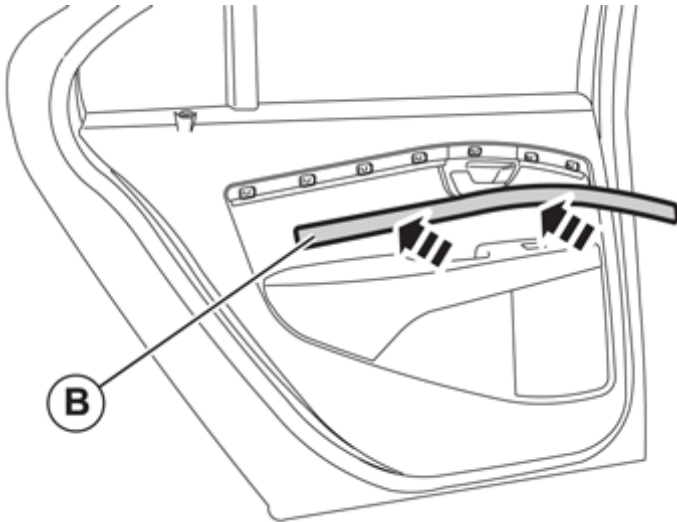

IMG-237394